

Cronus™ KITCHENWARE COLLECTION

Designed for Everyday. Crafted for Excellence.



 PREMIUM
QUALITY

 DURABLE &
RELIABLE

 PERFECT FOR
EVERY KITCHEN

 SAFE &
FOOD GRADE

 THOUGHTFUL
DESIGN

CATALOG 2026

18 JARS 360° REVOLVING SPICE RACK

ORGANIZE YOUR KITCHEN WITH STYLE & CONVENIENCE

The 3-Layer Revolving Spice Rack is designed to keep your favorite spices neatly arranged and easily accessible. Featuring smooth 360° rotation on every layer, this space-saving organizer adds functionality and elegance to any modern kitchen.

360°
ROTATING
EACH LAYER



KEY FEATURES

- ✔ 360° Smooth Rotating Layers
- ✔ 18 Transparent Spice Containers
- ✔ 250ml Capacity Per Jar
- ✔ 3-Tier Space Saving Design
- ✔ Easy Access & Visibility
- ✔ Durable Food-Grade Material
- ✔ Modern & Compact Appearance
- ✔ Ideal for Home & Professional Kitchens

SPECIFICATIONS

Product Code	: SC-01
Product Name	: 3-Layer Revolving Spice Rack
Number of Containers	: 18
Capacity	: 250ml Each
Layers	: 3
Rotation	: 360° Each Layer
Material	: Food Grade Plastic
Usage	: Spice & Dry Food Storage
Color	: Red / White / Black



EASY POUR SPOUT

Smart pour spout for mess-free seasoning and perfect control.



PREMIUM MATERIAL

Made from high quality food-grade plastic, safe, durable and built to last.



SPACE SAVING DESIGN

Compact 3-tier design saves countertop space while keeping everything organized and within reach.

AVAILABLE COLORS



● PINK



● TEAL



● GREY



● PURPLE

12 JAR 360° ROTATING SPICE RACK

ULTIMATE STORAGE SOLUTION

The 12 Jar 360° Rotating Spice Rack is designed to keep your spices organized, fresh, and within easy reach. With a smooth rotating design, durable jars, and a space-saving structure, it's the perfect addition to every modern kitchen.

360°
ROTATING
EACH LAYER



KEY FEATURES

- ✔ 12 Containers - 250ml Each
- ✔ Easy to Clean & Refill
- ✔ BPA Free
- ✔ Ideal for Spices
- ✔ 360° Smooth Rotation
- ✔ PP Plastic
- ✔ 2-Tier Design for Easy Access
- ✔ Air-Tight & Transparent Jars
- ✔ Space-Saving Design

SPECIFICATIONS

Product Code	: SC-02
Product Name	: 12 Jar Rotating Spice Rack
Number of Containers	: 12
Capacity	: 250ml Each
Layers	: 2
Rotation	: 360° Each Layer
Material	: PP Plastic (Food Grade)
Jar Type	: Air-Tight & Transparent
Usage	: Spice & Dry Food Storage
Color	: Teal / White / Black



EASY TO CLEAN & REFILL

Wide opening and smart design for effortless cleaning and refilling.



AIR-TIGHT & TRANSPARENT

Keeps spices fresh longer while clear jars ensure easy identification.



SPACE-SAVING DESIGN

Compact 2-tier rotating design saves countertop space and keeps your kitchen neat & organized.



AVAILABLE COLORS



PINK



TEAL



GREY



PURPLE

16 JARS REVOLVING SPICE RACK

SMART STORAGE. EASY ACCESS. EVERY TIME.

The 16 Jars Revolving Spice Rack combines smart design with maximum functionality. Its 2-tier revolving structure keeps your spices neatly organized, easy to find and within reach, while the sleek jars preserve freshness and add elegance to your kitchen.

KEY FEATURES

- ✔ 16 Premium Spice Jars Included
- ✔ 160ml Capacity Per Jar
- ✔ 360° Smooth Rotating Design
- ✔ 2-Tier Space Saving Structure
- ✔ Easy Access & Visibility
- ✔ Airtight Freshness Lock
- ✔ Durable & Easy to Clean
- ✔ Multi-Purpose Kitchen Organizer

SPECIFICATIONS

Product Code	: SC-03
Product Name	: 16 Jars Revolving Spice Rack
Number of Containers	: 16
Capacity	: 160ml Each
Layers	: 2
Rotation	: 360° Smooth Rotation
Material	: PP Plastic Rack + Transparent Jars
Jar Type	: Airtight Shaker Lids
Usage	: Spice & Dry Food Storage
Color	: Teal / Gold / Silver



PREMIUM SPICE JARS

High quality glass jars with shaker lids keep spices fresh, organized and easy to use.



360° REVOLVING DESIGN

Smooth revolving mechanism ensures easy access to every spice, every time.



SPACE-SAVING 2-TIER DESIGN

Compact 2-tier structure saves countertop space while keeping spices neatly organized.



AVAILABLE COLORS



● TEAL



● GOLD

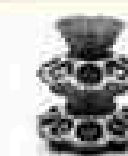

● SILVER

DOWNLOAD IMAGES

2-TIER DISH DRYING RACK

SMART KITCHEN ORGANIZER

The 2-Tier Dish Drying Rack is the perfect solution for a tidy and efficient kitchen. With smart storage, durable construction and a sleek design, it keeps your dishes, cutlery and utensils organized while ensuring fast drying and a clutter-free countertop.

KEY FEATURES

- 2-TIER SPACE SAVING DESIGN**
Maximize counter space & keeps kitchen organized
- MULTI-COMPARTMENT CUTLERY HOLDER**
Separate sections for spoons, forks, knives & other utensils
- DURABLE & RUST-FREE MATERIAL**
High-quality plastic construction for long-lasting use
- QUICK DRAIN SYSTEM**
Open design ensures fast water drainage & quick drying
- STRONG & STABLE BASE**
Sturdy frame holds heavy dishes without wobbling

SPECIFICATIONS

Product Code	: DR-01
Product Name	: 2-Tier Dish Drying Rack
Material	: High-Quality Plastic + Steel
Color	: Black & White
Capacity	: Plates, Bowls, Cutlery, Chopping Board & More
Layers	: 2 Tier
Usage	: Kitchen Storage & Drying
Dimensions	: 42 (L) x 24 (W) x 34 (H) cm



MATERIAL
High-Quality
Plastic + Steel



COLOR
Black & White



CAPACITY
Plates, Bowls,
Cutlery, Chopping
Board & More



LAYERS
2-Tier



USAGE
Kitchen Storage
& Drying



BUILT TO LAST
Strong & Durable



EASY TO CLEAN
Hassle-free Maintenance



BPA FREE
Safe & Non

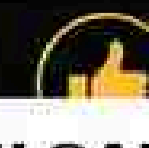

PERFECT FOR

MOTIVATIONAL WATER BOTTLE

Stay Motivated. Stay Hydrated.

KEY FEATURES

-  **TIME MARKED**
Stay on track with hourly goals
-  **LEAK PROOF**
Secure lid & silicone seal for zero leaks
-  **PREMIUM QUALITY**
Durable, crystal clear PET material
-  **PORTABLE HANDLE**
Easy to carry anywhere

**2000ML
CAPACITY**



**BUILT FOR
PERFORMANCE.
DESIGNED FOR
YOU.**

SPECIFICATIONS

Product Code	: WB-01
Product Name	: Motivational Water Bottle
Capacity	: 2000ML / 64OZ
Material	: PET
Lid Type	: Flip-Top with Lock
Handle	: Durable Carry Handle
Dimensions	: 29cm (H) x 11cm (D)
Weight	: 200GM
Usage	: Gym, Outdoor, Office, Daily Use

 YOGA Stay balanced Stay hydrated	 GYM Push harder Hydrate more	 OUTDOOR Take it anywhere Stay refreshed	 ECO-FRIENDLY Reusable & durable Better for tomorrow
--	--	---	---

WB-01

FREE STICKERS







**TIME MARKED
MOTIVATION**

SPECIFICATIONS

CAPACITY	: 2000ML / 64OZ
MATERIAL	: PET
LID TYPE	: FLIP-TOP WITH LOCK
HANDLE	: DURABLE CARRY HANDLE
DIMENSIONS	: 29cm (H) x 11cm (D)
WEIGHT	: 200GM
USAGE	: Gym, Outdoor, Office, Daily Use

AVAILABLE COLORS



 BUILT TO LAST Strong & Durable	 LEAK PROOF 100% Leak Free	 BPA FREE Safe & Non-Toxic	 PREMIUM QUALITY Crafted for Excellence
--	---	---	--

DOWNLOAD IMAGES

- PREMIUM DESIGNER PRINTS**
Unique & attractive artwork for stylish hydration.
- LEAK PROOF LID**
Secure flip top lid with lock for spill free use.
- BUILT-IN STRAW**
Convenient straw for easy and hassle-free sipping.
- TIME MARKER MOTIVATION SCALE**
Stay on track with time based water intake reminders.
- EASY CARRY HANDLE**
Comfortable handle for easy carrying anywhere.
- BPA FREE MATERIAL**
Made from safe, non-toxic & BPA free material.
- DURABLE PET CONSTRUCTION**
Lightweight, sturdy & built to last.
- PERFECT GIFT COLLECTION**
Ideal for gifting on any occasion.



DESIGNER MOTIVATIONAL WATER BOTTLE

Premium Printed Collection – Style Meets Hydration

SPECIFICATIONS

Product Code	:	WB-02
Product Name	:	Designer Motivational Water Bottle
Material	:	PET
Capacity	:	1000ML
Lid Type	:	Flip Top with Lock
Handle	:	Carry Handle
Weight	:	180gm
Usage	:	Daily Hydration, Gym, Office & Outdoor

CHAMELEON EDITION Vibrant & refreshing design for nature lovers.	FLAMINGO EDITION Bright, beautiful & inspiring design.	ELEPHANT EDITION Intricate art with premium quality finish.	PEACOCK EDITION Stunning & elegant artwork that stands out.
--	--	---	---

AVAILABLE DESIGNS

CHAMELEON	FLAMINGO	ELEPHANT	PEACOCK

LIGHTWEIGHT & DURABLE Built for everyday use	LEAK PROOF DESIGN 100% spill free experience	BPA FREE MATERIAL Safe, healthy & non-toxic	PERFECT FOR GIFTING
--	--	---	----------------------------

[DOWNLOAD IMAGES](#)

SPORTS MOTIVATIONAL WATER BOTTLE

Built for **Performance**.
Designed for **Everyday Hydration**.

KEY FEATURES

- LEAK-PROOF DESIGN**
100% leak-proof lid for worry-free use.
- BPA FREE MATERIAL**
Safe, non-toxic & odorless.
- BUILT-IN STRAW**
Convenient straw for easy & mess-free sipping.
- LIGHTWEIGHT & DURABLE**
Built to last and easy to carry anywhere.
- EASY GRIP SLEEVE**
Silicone sleeve for better grip & comfort.
- SAFETY LOCK LID**
Flip top lid with safety lock for extra security.
- MOTIVATIONAL PRINT**
Inspires you to stay focused & hydrated.
- PERFECT FOR GYM & OUTDOOR ACTIVITIES**
Ideal companion for your active lifestyle.



SPECIFICATIONS

Product Code	: WB-03
Material	: PET
Capacity	: 1000ML
Weight	: 180gm
Lid Type	: Flip Top with Safety Lock
Straw	: Built-in Straw
Handle	: Carry Strap
Usage	: Gym, Fitness, Office & Outdoor

AVAILABLE COLORS



PEACH



PURPLE



LIGHT BLUE



BLACK

LEAK-PROOF LID SYSTEM



Silicone seal ring ensures 100% leak-proof performance.

COMFORT GRIP SLEEVE



Anti-slip silicone sleeve provides a secure & comfortable grip during workouts.

BUILT-IN STRAW DESIGN



Built-in straw allows effortless sipping without lifting the bottle.

GYM & OUTDOOR USE

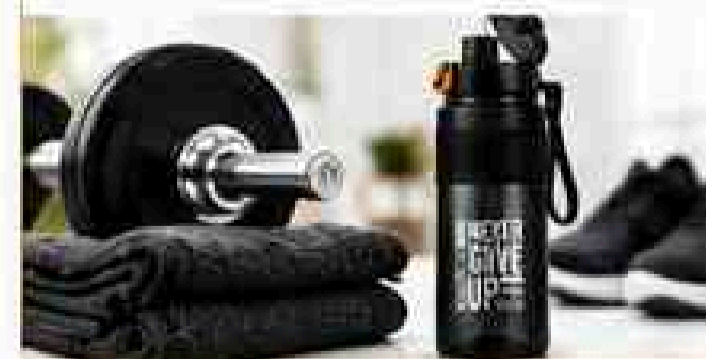

Perfect for gym, sports, hiking, office & all your daily activities.



PREMIUM SHAKER BOTTLE

Shake it. Mix it. Fuel your performance.

KEY FEATURES

- LEAK PROOF**
Secure flip lock lid for zero leaks
- MIXER BALL**
Stainless steel ball for smooth mixing
- DURABLE BUILD**
Made with premium PET material
- EASY TO CARRY**
Ergonomic handle for comfortable grip
- BPA FREE**
Safe, non-toxic & odor free

**700ML
CAPACITY**

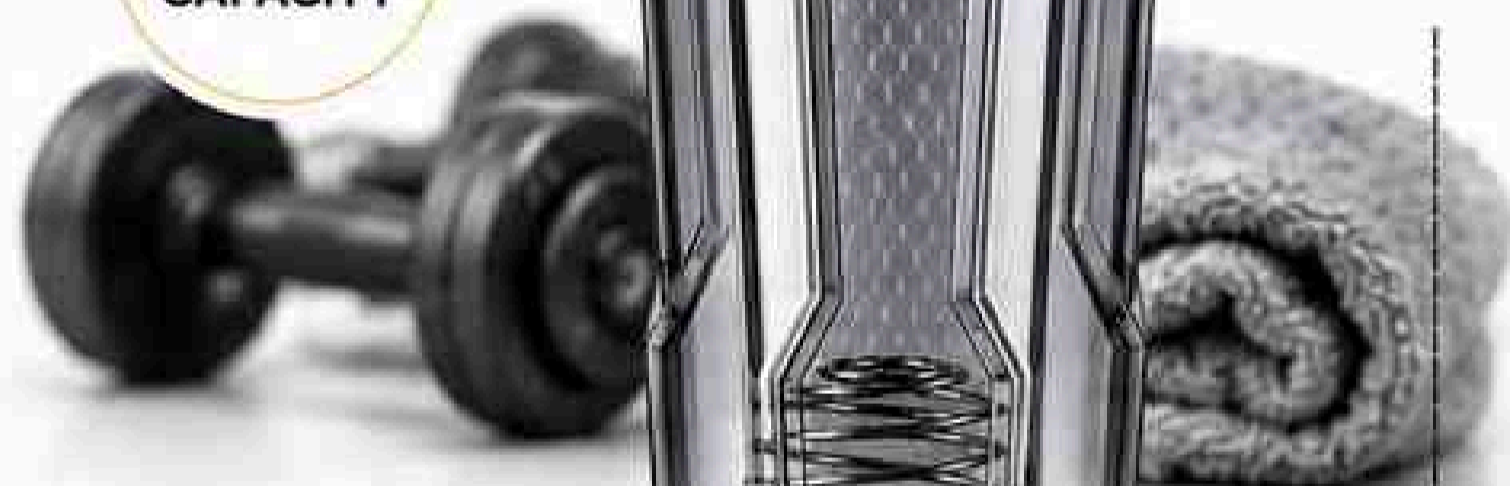

**24.5
cm**

7.5 cm



**BUILT FOR
PERFORMANCE.
DESIGNED FOR
YOU.**

WB-04
700ML SHAKER BOTTLE

SPECIFICATIONS

Product Code	: WB-04
Product Name	: Premium Shaker Bottle
Capacity	: 700ML / 24OZ
Material	: PET
Lid Type	: Flip-Top with Lock
Handle	: Ergonomic Carry Handle
Dimensions	: 24.5cm (H) x 7.5cm (D)
Weight	: 160GM
Usage	: Gym, Fitness, Sports, Daily Use



GYM
Perfect for protein shakes



SPORTS
Stay energized & hydrated



OFFICE
Great for work & on the go



OUTDOOR
Take it anywhere with you



ECO-FRIENDLY
Reusable & better for tomorrow

SPECIFICATIONS

CAPACITY	: 700ML / 24OZ
MATERIAL	: PET
LID TYPE	: FLIP-TOP WITH LOCK
HANDLE	: ERGONOMIC CARRY HANDLE
DIMENSIONS	: 24.5cm (H) x 7.5cm (D)
WEIGHT	: 160GM
USAGE	: Gym, Fitness, Sports, Daily Use



AVAILABLE COLORS



LEAK PROOF
100% Leak Free



STRONG & DURABLE
Built to Last Long

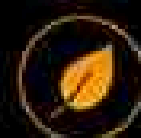

BPA FREE
Safe & Non-Toxic



MIXER BALL



PREMIUM QUALITY

DOWNLOAD IMAGES

PREMIUM SHAKER BOTTLE

Shake it. Mix it. Fuel your performance.

KEY FEATURES

- LEAK PROOF**
Secure flip lock lid for zero leaks
- MIXER BALL**
Stainless steel ball for smooth mixing
- DURABLE BUILD**
Made with premium PET material
- EASY TO CARRY**
Ergonomic handle for comfortable grip
- BPA FREE**
Safe, non-toxic & odor free

SPECIFICATIONS

CAPACITY	: 700ML / 24OZ
MATERIAL	: PET
LID TYPE	: FLIP-TOP WITH LOCK
HANDLE	: ERGONOMIC CARRY HANDLE
DIMENSIONS	: 23.5cm (H) x 7.5cm (D)
WEIGHT	: 150GM
USAGE	: Gym, Fitness, Sports, Daily Use



**700ML
CAPACITY**

**23.5
cm**

7.5 cm



**BUILT FOR
PERFORMANCE.
DESIGNED FOR
YOU.**

WB-05
700ML SHAKER BOTTLE

SPECIFICATIONS

Product Code	: WB-05
Product Name	: Premium Shaker Bottle
Capacity	: 700ML / 24OZ
Material	: PET
Lid Type	: Flip-Top with Lock
Handle	: Ergonomic Carry Handle
Dimensions	: 23.5cm (H) x 7.5cm (D)
Weight	: 150GM
Usage	: Gym, Fitness, Sports, Daily Use

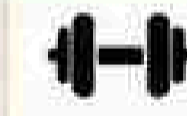

GYM
Perfect for protein shakes



SPORTS
Stay energized & hydrated



OFFICE
Great for work & on the go



OUTDOOR
Take it anywhere with you.



ECO-FRIENDLY
Reusable & better for tomorrow

AVAILABLE COLORS



LEAK PROOF
100% Leak Free



STRONG & DURABLE
Built to Last Long



BPA FREE
Safe & Non-Toxic



MIXER BALL

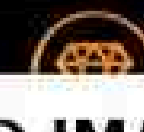

PREMIUM QUALITY

DOWNLOAD IMAGES

PREMIUM GYM & OUTDOOR BOTTLE

Hydrate. Perform. Repeat.

KEY FEATURES

- LEAK PROOF**
Secure flip lock lid for zero leaks
- LIGHTWEIGHT**
Made with premium PET material
- DURABLE BUILD**
Strong and impact resistant
- EASY TO CARRY**
Ergonomic carry handle for comfortable grip
- BPA FREE**
Safe, non-toxic & odor free

**1600ML
CAPACITY**



28.5
cm

9.2 cm



**BUILT FOR
PERFORMANCE.
DESIGNED FOR
YOU.**

WB-06

1600ML BOTTLE
GYM & OUTDOOR

SPECIFICATIONS

Product Code	: WB-06
Product Name	: Premium Gym & Outdoor Bottle
Capacity	: 1600ML / 54OZ
Material	: PET
Lid Type	: Flip-Top with Lock
Handle	: Ergonomic Carry Handle
Dimensions	: 28.5cm (H) x 9.2cm (D)
Weight	: 220GM
Usage	: Gym, Fitness, Sports, Outdoor

GYM Perfect for workouts	SPORTS Stay energized & hydrated	OUTDOOR Take anywhere with you	CYCLING Hydration on the move	HIKING Built for every adventure	CAMPING Your perfect outdoor partner

AVAILABLE COLORS

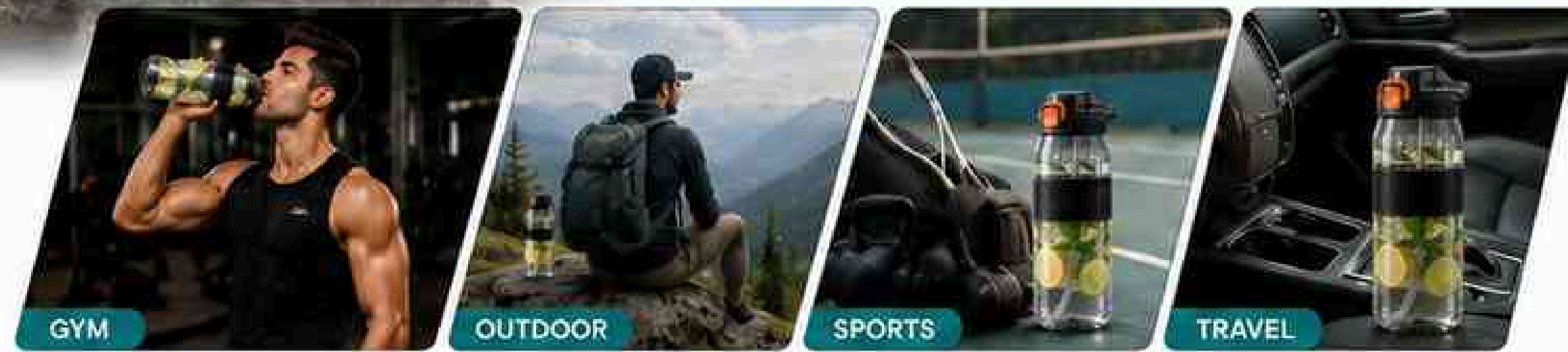

	LEAK PROOF 100% Leak Free		STRONG & DURABLE Built to Last Long		BPA FREE Safe & Non-Toxic		LIGHTWEIGHT Easy to Carry		PREMIUM QUALITY Engineered for Excellence
--	-------------------------------------	--	---	--	-------------------------------------	--	-------------------------------------	--	---

DOWNLOAD IMAGES



PORTABLE 3500 ML WATER BOTTLE

Stay Hydrated Anywhere at Home or On-the-Go

KEY FEATURES

- 
LARGE 3500 ML CAPACITY
 Large enough to keep you hydrated throughout the day.
- 
LEAK-PROOF FLIP-TOP LID
 Secure flip-top lid prevents leaks and spills.
- 
BPA-FREE & DURABLE
 Made from premium BPA-free material for safe and long-lasting use.
- 
BUILT-IN CARRYING HANDLE
 Ergonomic handle for easy carrying anywhere.



BLACK

COLOR VARIANTS



MINT GREEN



BLACK



EASY FILLING





EASY CARRY



REFRIGERATOR FRIENDLY

SPECIFICATIONS

Product Code	: WB-07
Product Name	: Portable 3500ml Water Bottle
Material	: Premium Food Grade Plastic
Capacity	: 3500 ml (Approx.)
Lid Type	: Flip-Top Lid
Leak Proof	: Yes
BPA Free	: Yes
Handle	: Yes
Color	: Mint Green, Black,
Suitable For	: Water, Juice, Lemonade, Detox Drinks & More
Usage	: Home, Office, Gym, Outdoor & Travel

- 
FOOD SAFE
 Safe for you and your family.
- 
LEAK PROOF
 100% leak-proof flip-top lid.
- 
LIGHTWEIGHT
 Easy to carry anywhere.
- 
EASY TO CLEAN
 Wide mouth for effortless.

TRAVEL KIT

COMPACT. ORGANIZED. READY TO GO.

All your essentials,
neatly packed for
every journey.

KEY FEATURES

- ALL-IN-ONE SOLUTION**
Includes pump bottles and comb for your daily essentials.
- COMPACT & PORTABLE**
Space-saving design fits perfectly in any bag or luggage.
- LEAK-PROOF DESIGN**
Secure pump bottles prevent leakage and spills.
- HIGH QUALITY MATERIAL**
Made from premium, BPA-free plastic for safe use.
- IDEAL FOR TRAVEL**
Perfect for vacations, business trips, gym, and more.
- EASY TO CLEAN**
Detachable parts for convenient cleaning and refilling.



PRODUCT DETAILS

- PUMP BOTTLES**
Equipped with smooth pump bottles for easy dispensing of liquids.
- BUILT-IN COMB**
Handy comb included for grooming on the go.
- COMPACT DESIGN**
Sleek and compact design saves space in your luggage.
- TRAVEL FRIENDLY**
Lightweight and easy to carry, perfect travel companion.

SET INCLUDES

- 2 Pcs Pump Bottles
- 1 Pc Comb
- 1 Pc Container Case
- (All in 1 Set)

SPECIFICATIONS

Product Code	: TK-01
Product Name	: Travel Kit
Material	: High Quality Plastic
Set Includes	: 2 Pump Bottles, 1 Comb, 1 Container Case (All in 1 Set)
Color	: Blue, Pink
BPA Free	: Yes
Leak Proof	: Yes
Compact Design	: Yes
Usage	: Travel, Vacation, Business Trip, Gym & Daily Use
Dimension (LxWxH):	7.5 x 7.5 x 20.5 cm

COLORS AVAILABLE



- ALL-IN-ONE SOLUTION**
Everything you need, neatly in one kit.
- LEAK-PROOF DESIGN**
Secure pumps to keep your liquids safe.
- HIGH QUALITY MATERIAL**
Durable, BPA-free plastic for long lasting use.
- COMPACT & PORTABLE**
Easy to carry, perfect for travel.



SPORTS WATER BOTTLE

STAY HYDRATED. STAY ACTIVE.

Built for Performance.
Made for Everyday Use.

KEY FEATURES

- FOOD GRADE MATERIAL**
Made from premium food grade material, safe and non-toxic.
- LEAK-PROOF LID**
Secure flip-top lid with silicone seal to prevent leaks and spills.
- BUILT-IN JUICER**
Removable juicer for adding fresh flavor to your drinks.
- EASY GRIP HANDLE**
Ergonomic handle for a comfortable and firm grip.
- PERFECT FOR ACTIVE LIFESTYLE**
Ideal for gym, outdoor sports, travel, office & daily use.



SPECIFICATIONS

Product Code	: SWB-01
Product Name	: Sports Water Bottle
Material	: Food Grade Plastic
Capacity	: 1500 ML
Lid Type	: Flip-Top with Spout
Juicer	: Built-in Removable Juicer
Handle	: Easy Grip Handle
Color	: Smoke Grey with Orange Accents
Usage	: Gym, Sports, Outdoor, Office & Daily Use
BPA Free	: Yes
Leak Proof	: Yes
Package Includes	: 1 Pc Sports Water Bottle with Built-in Juicer

IDEAL FOR EVERYDAY USE



LEMON WATER

FRUIT INFUSED WATER

DETOX WATER

FRESH JUICE

PLAIN WATER



FOOD SAFE
Made from food grade material, safe & healthy.



LEAK PROOF
Leak-proof design for worry-free use.



BPA FREE
100% BPA-free and non-toxic.

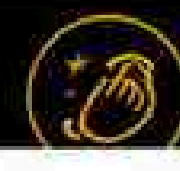

EASY TO CLEAN
Wide mouth opening for easy cleaning.

DOWNLOAD IMAGES

PUZZLE LUNCH BOX

**Smart Portions.
Perfect Combination.**

KEY FEATURES

-  **PUZZLE DESIGN**
Interlocking containers for balanced meals.
-  **FOOD GRADE MATERIAL**
Safe, non-toxic & BPA free.
-  **AIRTIGHT LID**
Keeps food fresh & leak resistant.
-  **MICROWAVE SAFE**
Container is microwave safe (without lid).
-  **PERFECT PORTIONS**
Ideal for lunch, snacks, fruits & more.
-  **COMPLETE SET**
Comes with spoon & fork for convenience.
-  **TRAVEL FRIENDLY**
Compact, lightweight & easy to carry.
-  **EASY TO CLEAN**
Smooth surface for hassle-free cleaning.

 **FREE STICKERS**
Fun & vibrant stickers to personalize your lunch box!



SPECIFICATIONS

Product Code	: PLB-01
Capacity	: 2 x 250ml Containers 1 x 500ml Container
Material	: Food Grade PP (BPA Free)
Dimensions	: 18cm x 18cm x 6cm (Assembled)
Weight	: 350g
Microwave Safe	: Yes (Container Only)
Freezer Safe	: Yes
Includes	: 3 Containers, 1 Spoon, 1 Fork

PUZZLE DESIGN



Interlocking lids fit perfectly for a secure hold.

AIRTIGHT & LEAK RESISTANT



Tight seal lids keep food fresh and prevent leakage.

COMPLETE SET



Comes with spoon & fork for convenience.

SMART LUNCH. HEALTHY YOU.

PREMIUM LUNCH BOX

Pack **Fresh**. Eat **Healthy**.
Every Day, **Everywhere**.

KEY FEATURES

- LEAK-PROOF DESIGN**
Silicone seal ring ensures 100% leak-proof performance.
- FOOD GRADE MATERIAL**
Made from BPA free, food grade PET material. Safe & non-toxic.
- SECURE SIDE LOCKS**
Strong side locks keep your lunch secure and fresh.
- LIGHTWEIGHT & DURABLE**
Sturdy yet lightweight design for everyday convenience.
- BUILT-IN CUTLERY**
Spoon & fork included and stored safely under the clear lid.
- MICROWAVE SAFE**
No. Not safe for microwave use.
- DISHWASHER SAFE**
No. Not safe for dishwasher use.
- Ideal for office, school, travel, gym & outdoor activities.**



SPECIFICATIONS

Product Code	: LB-01
Product Name	: Premium Lunch Box
Material	: PET (BPA Free)
Dimensions (L x W x H)	: 22 x 11 x 12 cm
Compartments	: 2 or 3 Tier
Lid Type	: Clear Lid with Cutlery Compartment
Lock Type	: Easy Lock Side Clips
Microwave Safe	: No
Dishwasher Safe	: No
Usage	: Office, School, Travel, Picnic, Gym

AVAILABLE COLORS



LEAK-PROOF LID

Silicone seal ring prevents any leaks and keeps food fresh for hours.



SECURE SIDE LOCKS

Sturdy lock mechanism ensures tight closure and spill-free travel.



BUILT-IN CUTLERY

Spoon & fork included for hassle-free and hygienic mealtimes.



SMART STORAGE.
FUN EVERYDAY.
MADE FOR KIDS!

LB-02
STEEL BENTO BOX

STEEL BENTO BOX

Smart Portions.
Perfect Combination.



MADE WITH
STAINLESS STEEL
INSIDE

KEY FEATURES

- PUZZLE DESIGN**
Interlocking lids fit perfectly for a secure hold.
- PERFECT PORTIONS**
Ideal for lunch, snacks, fruits & more.
- FOOD GRADE MATERIAL**
Made with premium food grade PP (BPA Free).
- COMPLETE SET**
Comes with spoon & fork for convenience.
- AIRTIGHT & LEAK PROOF**
Secure lock system keeps food fresh & mess free.
- TRAVEL FRIENDLY**
Compact, lightweight & easy to carry.
- MICROWAVE SAFE**
Container is microwave safe (without lid).
- EASY TO CLEAN**
Smooth surface for hassle-free cleaning.

SPECIFICATIONS

Product Code	: LB-02
Product Name	: Steel Bento Box
Total Capacity	: 1000ML (Single Container)
Material	: Stainless Steel (Inside) Food Grade PP (Outside)
Compartments	: 1 (Single Container)
Lid Type	: Airtight Lid with Lock
Weight	: 320GM
Usage	: School, Office, Picnic, Travel & Daily Use

- LEAK PROOF**
Keeps food fresh & prevents spills
- BPA FREE**
Safe for kids, healthy for life
- DURABLE BUILD**
Strong, sturdy & built to last

AVAILABLE COLORS



- AIRTIGHT & LEAK PROOF**
Locks in freshness
- FOOD GRADE MATERIAL**
Safe & healthy for kids
- SINGLE CONTAINER**
1000ml complete meals
- KID FRIENDLY**
- EASY TO CLEAN**

STEEL BENTO BOX

Smart Portions.
Perfect Combination.



MADE WITH
STAINLESS STEEL
INSIDE



SMART STORAGE.
FUN EVERYDAY.
MADE FOR KIDS!

LB-04
STEEL BENTO BOX

KEY FEATURES

- 3 COMPARTMENT DESIGN**
Keeps different foods separated & fresh.
- PERFECT PORTIONS**
Ideal for lunch, snacks, fruits & more.
- PREMIUM MATERIAL**
Food grade stainless steel inside for safe eating.
- COMPLETE SET**
Comes with spoon & fork for convenience.
- AIRTIGHT & LEAK PROOF**
Secure lock system keeps food fresh & mess free.
- TRAVEL FRIENDLY**
Compact, lightweight & easy to carry.
- MICROWAVE SAFE**
Container is microwave safe (without lid).
- EASY TO CLEAN**
Smooth surface for hassle-free cleaning.



SPECIFICATIONS

Product Code	: LB-04
Product Name	: Steel Bento Box
Total Capacity	: 1000ML (3 Compartment)
Material	: Stainless Steel (Inside) Food Grade PP (Outside)
Compartments	: 3 (Fixed)
Lid Type	: Airtight Lid with Lock
Weight	: 340GM
Usage	: School, Office, Picnic, Travel & Daily Use

- LEAK PROOF**
Keeps food fresh & prevents spills
- BPA FREE**
Safe for kids, healthy for life
- DURABLE BUILD**
Strong, sturdy & built to last

AVAILABLE COLORS



GREEN



ORANGE



SCHOOL



HOME



PICNIC



TRAVEL



WASHING MACHINE STAND

WITH LOCK WHEELS

Strong Support.
Easy Movement.

KEY FEATURES

-  **STRONG & STURDY**
Heavy-duty construction for superior load-bearing capacity.
-  **360° LOCK WHEELS**
Smooth-rolling wheels for effortless movement. Lockable for extra stability.
-  **ADJUSTABLE SIZE**
Fits most washing machines, refrigerators & appliances.
-  **LOCKABLE WHEELS**
Locking mechanism keeps the stand firmly in place.
-  **ANTI-SLIP DESIGN**
Textured pads prevent vibration and provide extra grip.
-  **EASY TO ASSEMBLE**
Quick setup, no special tools required.

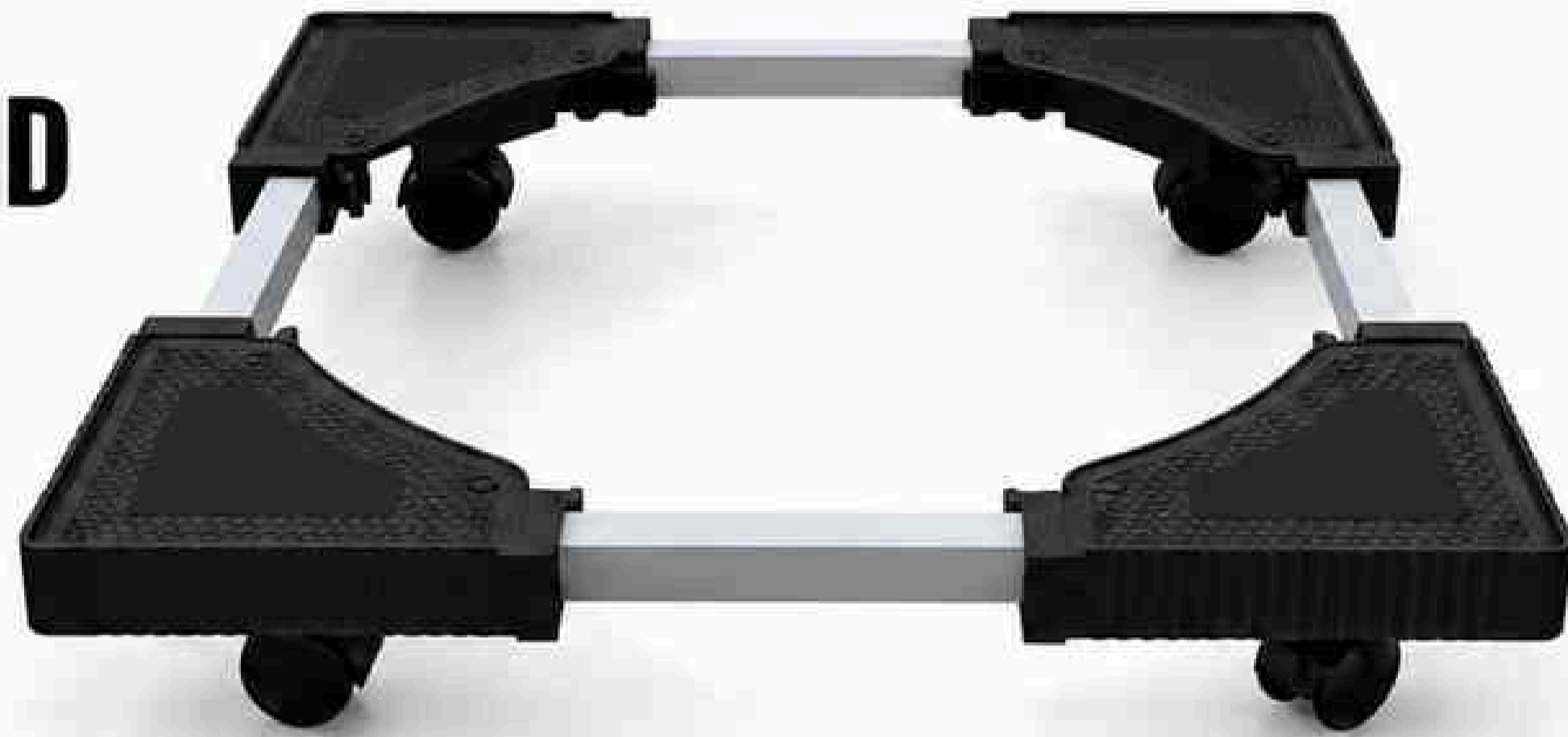

SUITABLE FOR



SPECIFICATIONS

Product Code	: WM-01
Material	: Steel Tube, PP Plastic & Lock Wheels
Adjustable Size	: 41cm - 65cm (Length/Width)
Height	: 10cm (Approx.)
Load Capacity	: Up to 150kg
Wheels	: 4 (360° Rotating with Lock)
Lockable Wheels	: 4
Anti-Slip Pads	: Yes
Suitable For	: Washing Machines, Refrigerators, Dishwashers & More
Includes	: 4 Corner Bases, 4 Bars, 4 Lock Wheels, Assembly Guide



LV-01

APPLIANCE LEVELING FEET

STABLE SUPPORT. PERFECT BALANCE.

Adjustable. Durable. Reliable.
Built for Every Surface.



KEY FEATURES

- STRONG & DURABLE**
Made from premium quality plastic for long-lasting strength and stability.
- HEIGHT ADJUSTABLE**
Easily adjust height to level appliances on uneven floors or surfaces.
- ANTI-SLIP BASE**
Wide, non-slip base ensures excellent grip and prevents movement or vibration.
- SHOCK & VIBRATION ABSORBING**
Reduces noise and vibration from washing machines, refrigerators & other appliances.
- EASY TO INSTALL**
No tools required. Simply screw to adjust height and secure in place.
- VERSATILE USE**
Suitable for washing machines, refrigerators, dryers, cabinets, sofas & more.



PRODUCT DETAILS

- HEIGHT ADJUSTABLE**
Screw design allows easy height adjustment to ensure perfect leveling.
- HEAVY DUTY SUPPORT**
Strong build supports heavy appliances and keeps them firmly in place.
- STABLE & SECURE**
Anti-slip base provides maximum stability and floor protection.
- EASY INSTALLATION**
Simple screw mechanism for quick installation without any tools.

SET INCLUDES

4 PCS
(1 Set)

COLOR: BLACK

SPECIFICATIONS

- Product Code : LV-01
- Product Name : Appliance Leveling Feet
- Material : High Quality Plastic
- Set Includes : 4 Pcs (1 Set)
- Color : Black
- Adjustable Height : Yes
- Base Type : Anti-Slip
- Load Capacity : Heavy Duty Support
- Installation : Tool Free
- Usage : Washing Machine, Refrigerator, Dryer, Cabinets, Sofas & More
- Floor Protection : Yes
- Durability : High
- Rust Resistant : Yes
- Vibration Control : Yes
- Package Includes : 4 Pcs Leveling Feet



STRONG & DURABLE
Built with premium quality material for long life.



HEIGHT ADJUSTABLE
Easy to adjust the height for perfect balance on any surface.



VIBRATION CONTROL
Reduces vibration and noise from heavy appliances.



WIDE COMPATIBILITY
Ideal for all major home appliances and furniture.



SMART STORAGE.
FUN EVERYDAY.
MADE FOR KIDS!

DFC-01
DRY FRUIT CUTTER

DRY FRUIT CUTTER

Smart Cutting.
Perfect Pieces.



KEY FEATURES



SHARP STAINLESS STEEL BLADES
Precision cutting for almonds, cashews & more.



SAFE & EASY TO USE
Ergonomic design for comfortable grip & safety.



FOOD GRADE MATERIAL
Made with premium food grade ABS & transparent container.

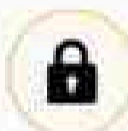

LOCK & STORE SYSTEM
Twist lock mechanism keeps contents fresh & secure.

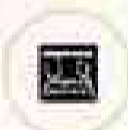

EASY TO CLEAN
Detachable parts for quick & hassle-free cleaning.



COMPACT & PORTABLE
Lightweight & space saving, easy to carry anywhere.



DURABLE BUILD
Strong & sturdy build for long lasting performance.



MULTI PURPOSE USE
Ideal for dry fruits, nuts, chocolates & more.



Cuts dry fruits evenly in seconds.
Save time, enjoy healthy bites!



ALMONDS



CASHEWS



PISTACHIOS

SPECIFICATIONS

Product Code	: DFC-01
Product Name	: Dry Fruit Cutter
Material	: Food Grade ABS (Body) Stainless Steel (Blades) Transparent PS (Container)
Blade Material	: Stainless Steel
Dimensions	: 8.5cm (H) x 6.5cm (Dia)
Capacity	: 150ml (Approx.)
Color Options	: Blue, Green
Weight	: 120gm (Approx.)
Usage	: Home, Kitchen, Travel, Office, Gifting



SHARP BLADES
Stainless steel blades for perfect cutting



FOOD GRADE
Safe material for healthy living



LOCK & STORE
Twist lock system for freshness

AVAILABLE COLORS



GREEN



BLUE

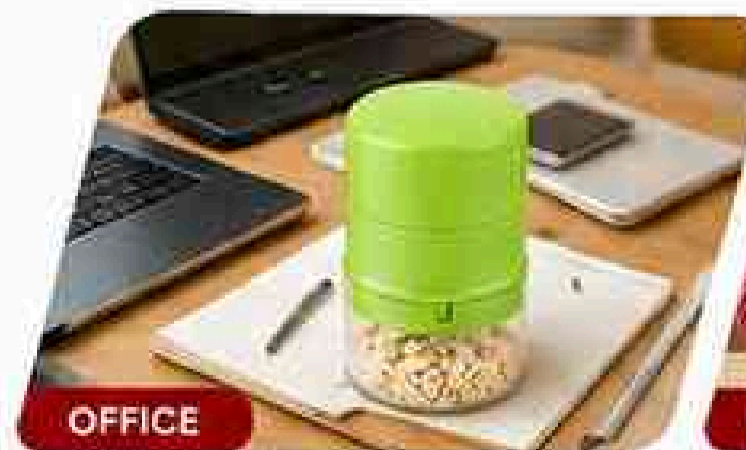

OFFICE



HOME



PICNIC



TRAVEL



SHARP STAINLESS STEEL BLADES
Precision cutting



FOOD GRADE MATERIAL
Safe & healthy for you



COMPACT & PORTABLE
Easy to carry anywhere

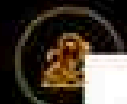

EASY TO CLEAN



DURABLE & LONG LASTING



WALL MOUNTED CUTLERY STAND

Smart Kitchen Organization Solution

SPECIFICATIONS

Product Code	: CS-01
Product Name	: Wall Mounted Cutlery Stand
Material	: Premium ABS Plastic
Length	: 40 cm
Height	: 7.4 cm
Depth	: 5.5 cm
Installation	: Wall Mounted / Adhesive Mount
Color	: Black
Usage	: Kitchen Storage & Organization

**MULTI-PURPOSE
KITCHEN ORGANIZER**
Keep your essentials
neatly organized

**DEDICATED KNIFE
STORAGE SLOTS**
Safe & convenient
knife storage

**STRONG
UTILITY HOOKS**
Hold kitchen tools
securely

**INTEGRATED
TOWEL HOLDER**
Easy access to
towels & clothes

**DURABLE ABS
PLASTIC CONSTRUCTION**
Sturdy, lightweight
& long lasting

**SPACE SAVING
WALL MOUNTED DESIGN**
Utilize wall space
& keep countertop clear

**EASY INSTALLATION
WITHOUT DRILLING**
Strong adhesive mount
for quick setup

**MODERN & ELEGANT
APPEARANCE**
Stylish design complements
any kitchen décor



AVAILABLE COLORS

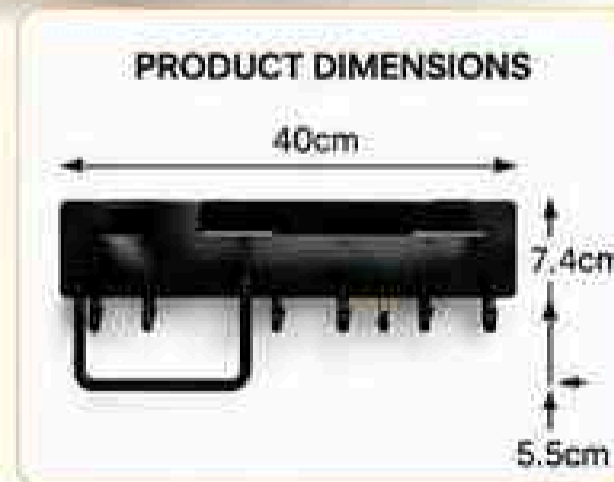
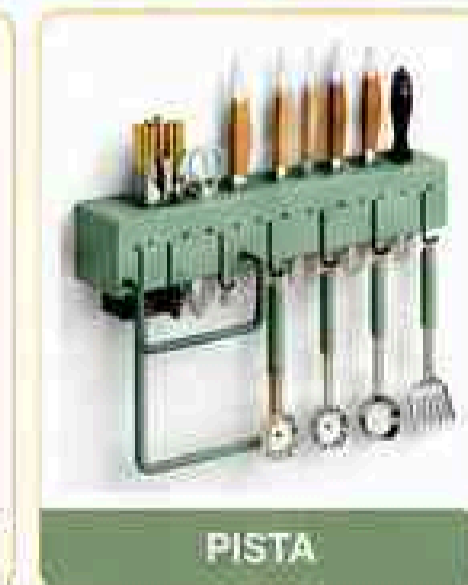



CUTLERY ORGANIZER

ORGANIZED. HYGIENIC. EFFORTLESS.

Smart storage for a neat and modern kitchen.

KEY FEATURES

- GROOVE DESIGN**
Unique groove pattern for easy access to your silverware.
- MULTIPLE COMPARTMENTS**
Spacious sections to neatly store all types of cutlery and utensils.
- DURABLE & STRONG**
Made from high quality food grade plastic for long lasting performance.
- EASY TO CLEAN**
Smooth surface for quick cleaning and maintenance.
- BPA FREE & SAFE**
100% BPA free, non-toxic and completely safe for everyday use.



PRODUCT DETAILS

- GROOVE DESIGN**
Groove design for smooth and easy access to cutlery.
- SPACIOUS COMPARTMENTS**
Designed compartments to keep spoons, forks, knives & more organized.
- PREMIUM QUALITY PLASTIC**
High quality plastic ensures strength, durability & safety.
- EASY TO CLEAN**
Smooth surface makes it easy to clean and hygienic to use.

SET INCLUDES

1 Pc (Tray)
(7 Compartments)

SPECIFICATIONS

Product Code	: CO-01
Product Name	: Cutlery Organizer
Material	: High Quality Plastic
Set Includes	: 1 Pc (Tray)
Color	: Black
Compartments	: 7 Sections
Groove Design	: Yes
BPA Free	: Yes
Dishwasher Safe	: Yes
Usage	: Kitchen Drawer Organizer
Dimension (LxWxH)	: 38.5 x 29 x 5.5 cm

DIMENSION



- STRONG & DURABLE**
Built with premium quality material for long life.
- EASY TO CLEAN**
Smooth surface for quick & easy cleaning.
- SPACIOUS DESIGN**
Multiple compartments for perfect organization.
- BPA FREE & SAFE**
Non-toxic, BPA free and safe for daily use.



RIBBED GLASS TUMBLER

ELEGANT DESIGN. EVERYDAY LUXURY.

Stylish. Durable.
Perfect for Every Sip.

KEY FEATURES

- PREMIUM QUALITY GLASS**
Made from high-quality, food grade glass for safe and long-lasting use.
- UNIQUE RIBBED DESIGN**
Vertical ribbed texture for elegant look and comfortable grip.
- PERFECT FOR EVERY DRINK**
Ideal for juices, cold drinks, water, cocktails and more.
- EASY TO CLEAN**
Smooth surface and sturdy design for effortless washing and maintenance.
- DURABLE & STURDY**
Thick glass construction ensures durability and everyday reliability.



SPECIFICATIONS

Product Code	: GL-01
Product Name	: Ribbed Glass Tumbler
Material	: Premium Quality Glass
Capacity	: 300 ml (Approx.)
Design	: Vertical Ribbed
Color	: Transparent
Usage	: Juice, Water, Cold Drinks, Cocktails & More
Dishwasher Safe	: Yes
Microwave Safe	: No
Package Includes	: 6 Pcs Glass Tumbler

IDEAL FOR EVERYDAY USE



- FOOD GRADE GLASS**
100% food grade glass safe for daily use.
- ELEGANT & STYLISH**
Modern ribbed design adds elegance to table.
- COMFORTABLE GRIP**
Ribbed texture for better hold.
- PERFECT GIFT CHOICE**
Stylish and premium, ideal for gifting.



FS-02

PREMIUM DRINKING GLASS

ELEGANT. DURABLE. EVERYDAY ESSENTIAL.

Crystal Clear. Stylish Design.
Perfect for Every Occasion.

KEY FEATURES

- PREMIUM QUALITY MATERIAL**
Made from high-quality, food grade PET plastic, safe, durable and long-lasting.
- CRYSTAL CLEAR VISIBILITY**
Transparent design for easy visibility and a touch of elegance.
- STYLISH & MODERN DESIGN**
Textured pattern for a sophisticated look and better grip.
- FOOD GRADE & BPA FREE**
100% food grade material, BPA free and odorless for safe everyday use.
- EASY TO CLEAN**
Smooth surface for effortless cleaning. Just rinse and reuse.



PRODUCT SIZE

- HEIGHT**
9 CM
- DIAMETER**
8 CM
- CAPACITY**
350 ML

PERFECT FOR

- Water
- Juice
- Cold Drinks
- Daily Use

FEATURES

- Crystal Clear Clarity
- Elegant Textured Design
- Comfortable Grip
- Durable & Long Lasting

IDEAL FOR EVERYDAY USE

SPECIFICATIONS

- Product Code** : FS-02
- Product Name** : Premium Drinking Glass
- Material** : PET Plastic
- Capacity** : 350 ML
- Dimensions** : Height - 9 CM
Diameter - 8 CM
- Color** : Transparent
- Feature** : Elegant Textured Design
- Usage** : Water, Juice, Cold Drinks & More
- BPA Free** : Yes
- Freezer Safe** : Yes
- Package Includes** : 1 Pc Premium Drinking Glass



FOOD SAFE
100% food grade PET plastic, safe & healthy.



DURABLE
Strong and crack-resistant for long-lasting use.



EASY TO CLEAN
Smooth surface ensures effortless cleaning.



STYLISH DESIGN
Modern textured design for an elegant look and feel.



DG-01

PREMIUM DRINKING GLASS

ELEGANT. DURABLE. EVERYDAY ESSENTIAL.

Crystal Clear. Stylish Design.
Perfect for Every Occasion.

KEY FEATURES

- PREMIUM QUALITY MATERIAL**
Made from high-quality, food grade material, safe, durable and long-lasting.
- CRYSTAL CLEAR VISIBILITY**
Transparent design for easy visibility and a touch of elegance.
- STYLISH & MODERN DESIGN**
Diamond textured pattern for a sophisticated look and better grip.
- FOOD GRADE & BPA FREE**
100% food grade material, BPA free and odorless for safe everyday use.
- EASY TO CLEAN**
Smooth surface for effortless cleaning. Just rinse and reuse.



PRODUCT SIZE

- HEIGHT**
12 CM
- DIAMETER**
7 CM
- CAPACITY**
300 ML

PERFECT FOR

- Water
- Juice
- Cold Drinks
- Daily Use

FEATURES

- Crystal Clear Clarity
- Diamond Textured Design
- Comfortable Grip
- Durable & Long Lasting

IDEAL FOR EVERYDAY USE

SPECIFICATIONS

Product Code	: DG-01
Product Name	: Premium Drinking Glass
Material	: Food Grade Plastic (PET Plastic)
Capacity	: 300 ML
Dimensions	: Height - 12 CM Diameter - 7 CM
Color	: Transparent
Feature	: Diamond Textured Design
Usage	: Water, Juice, Cold Drinks & More
BPA Free	: Yes
Microwave Safe	: No
Dishwasher Safe	: No
Package Includes	: 1 Pc Premium Drinking Glass



FOOD SAFE
100% food grade material, safe & healthy.



DURABLE
Strong and break-resistant for long-lasting use.



EASY TO CLEAN
Smooth surface ensures effortless cleaning.



STYLISH DESIGN
Modern diamond texture for a premium look.



TG-03

PREMIUM DRINKING GLASS SET

ELEGANT. DURABLE. EVERYDAY ESSENTIAL.

Crystal Clear. Stylish Design.
Perfect for Every Occasion.

KEY FEATURES

- PREMIUM QUALITY MATERIAL**
Made from high-quality, food grade **PET plastic**, safe, durable and long-lasting.
- CRYSTAL CLEAR VISIBILITY**
Transparent design for easy visibility and a touch of elegance.
- STYLISH & MODERN DESIGN**
Sleek and modern look that complements any table setting.
- FOOD GRADE & BPA FREE**
100% food grade material, BPA free and odorless for safe everyday use.
- EASY TO CLEAN**
Smooth surface for effortless cleaning. Just rinse and reuse.



PRODUCT SIZE

- HEIGHT**
11.94 CM
(Reduced by 0.5%)
- DIAMETER**
7 CM
- CAPACITY**
300 ML

PERFECT FOR

- Water
- Juice
- Cold Drinks
- Daily Use

SET INCLUDES

- 1 Pc - Smoked Grey
- 1 Pc - Clear
- 1 Pc - Blue

TOTAL: 3 PIECES

SPECIFICATIONS

- Product Code : TG-03
- Product Name : Premium Drinking Glass Set
- Material : PET Plastic
- Capacity : 300 ML (Each)
- Dimensions : Height - 11.94 CM
Diameter - 7 CM
- Color : Smoked Grey, Clear, Blue
- Feature : Elegant & Modern Design
- Usage : Water, Juice, Cold Drinks & More
- BPA Free : Yes
- Microwave Safe : No
- Dishwasher Safe : No
- Freezer Safe : Yes
- Package Includes : 3 Pcs Premium Drinking Glasses



FOOD SAFE
100% food grade material, safe & healthy.



DURABLE
Strong and break-resistant for long-lasting use.



EASY TO CLEAN
Smooth surface ensures effortless cleaning.



STYLISH DESIGN
Modern look that enhances your dining experience.



7 PIECES FRIDGE STORAGE CONTAINER

ORGANIZE BETTER. STORE SMARTER.

Clear. Stackable. Space-Saving.
Perfect for Every Kitchen.

KEY FEATURES

- PREMIUM QUALITY MATERIAL**
Made from high-quality, PET plastic, safe, durable and long-lasting.
- STACKABLE DESIGN**
Smart stackable structure saves space and keeps your kitchen organized.
- CRYSTAL CLEAR VISIBILITY**
Transparent body for quick identification of contents inside.
- FOOD GRADE & BPA FREE**
100% food grade material, BPA free and odorless for safe food storage.
- EASY TO CLEAN**
Smooth surface for effortless cleaning.



PRODUCT SIZE

Small (450ML)



4 PCS 450ML 4.84IN x 2.95IN x 2.17IN

Medium (1500ML)



2 PCS 1500ML 10.43IN x 3.54IN x 3.35IN

Large (4000ML)



1 PC 4000ML 11.81IN x 7.87IN x 3.86IN

SET INCLUDES

- 4 Pcs x 450 ML
- 2 Pcs x 1500 ML
- 1 Pc x 4000 ML

TOTAL: 7 PIECES

SPECIFICATIONS

Product Code	:	FS-01
Product Name	:	7 Pieces Fridge Storage Container
Material	:	PET Plastic
Set Includes	:	4 Pcs x 450 ML 2 Pcs x 1500 ML 1 Pc x 4000 ML
Color	:	Transparent
Lid Type	:	Airtight Locking Lid
Feature	:	Stackable & Space-Saving
Usage	:	Kitchen, Pantry, Refrigerator, Freezer & More
BPA Free	:	Yes
Microwave Safe	:	No
Freezer Safe	:	Yes
Package Includes	:	7 Pcs Fridge Storage Container Set in 3 Different Sizes



FOOD SAFE
100% food grade PET plastic, safe & healthy.



SPACE SAVER
Stackable design saves space and keeps your kitchen neat.



CRYSTAL CLEAR
Transparent design for easy visibility and quick identification.





SC-05

PREMIUM STORAGE CONTAINER SET

ORGANIZE BETTER. STORE SMARTER.

Clear. Airtight. Space-Saving.
Perfect for Every Kitchen.

KEY FEATURES

- PREMIUM QUALITY MATERIAL**
Made from high-quality PET plastic, safe, durable and long-lasting.
- CRYSTAL CLEAR VISIBILITY**
Transparent design for easy identification of contents.
- AIRTIGHT & LEAK-PROOF**
Secure locking lid with silicone seal keeps food fresh and prevents moisture.
- FOOD GRADE & BPA FREE**
100% food grade material, BPA free and odourless for safe food storage.
- EASY TO CLEAN**
Smooth surface for effortless cleaning. Hand wash recommended.



PRODUCT SIZE

- HEIGHT**
10.5 CM
- LENGTH & WIDTH**
10.5 CM
- CAPACITY**
500 ML (Each)

PERFECT FOR

- Pulses
- Spices
- Dry Fruits
- Snacks
- Grains

SET INCLUDES

- 6 Pcs Containers (500 ML Each)
- 6 Pcs Airtight Lids
- 6 Pcs Measuring Spoons

TOTAL: 18 PIECES

SPECIFICATIONS

Product Code	: SC-05
Product Name	: Premium Storage Container Set
Material	: PET Plastic
Capacity	: 500 ML (Each)
Dimensions	: Height - 10,5 CM Length - 10,5 CM Width - 10,5 CM
Color	: Transparent
Feature	: Airtight & Leak-Proof
Usage	: Kitchen, Pantry, Refrigerator & More
BPA Free	: Yes
Microwave Safe	: No
Dishwasher Safe	: No
Freezer Safe	: Yes
Package Includes	: 6 Pcs Containers (500 ML) 6 Pcs Lids 6 Pcs Measuring Spoons

NO MICROWAVE SAFE

NO DISHWASHER SAFE

MATERIAL: PET PLASTIC

- FOOD SAFE**
100% food grade material, safe & healthy.
- SPACE SAVER**
Stackable design saves space and keeps your kitchen neat.
- FRESH & ORGANIZED**
Airtight seal keeps food fresh and your kitchen organized.
- CRYSTAL CLEAR**
Transparent design for easy visibility and quick identification.

DOWNLOAD IMAGES



PC-05

1000ML RANDOM CONTAINER

ORGANIZE BETTER. STORE SMARTER.

Clear. Space-Saving.
Perfect for Every Kitchen.

KEY FEATURES

- PREMIUM QUALITY MATERIAL**
Made from high-quality, food grade PET plastic, safe, durable and long-lasting.
- CRYSTAL CLEAR VISIBILITY**
Transparent design for easy identification of contents.
- AIR TIGHT LOCKING LID**
Secure locking lid with silicone seal keeps food fresh and prevents moisture.
- FOOD GRADE & BPA FREE**
100% food grade material, BPA free and odorless for safe food storage.
- EASY TO CLEAN**
Smooth surface for effortless cleaning. Hand wash recommended.



PRODUCT SIZE

- HEIGHT**
16.5 CM
- LENGTH & WIDTH**
10.5 CM
- CAPACITY**
1000 ML (Each)

PERFECT FOR

- Pulses
- Spices
- Dry Fruits
- Snacks
- Grains

SET INCLUDES

- 6 Pcs Containers (1000 ML Each)
- 6 Pcs Airtight Lids

TOTAL: 6 PIECES

SPECIFICATIONS

- Product Code : PC-05
- Product Name : 1000ml Random Container
- Material : PET Plastic
- Capacity : 1000 ML (Each)
- Dimensions : Height - 16.5 CM
Length - 10.5 CM
Width - 10.5 CM
- Color : Transparent with Grey Lid
- Feature : Airtight Locking Lid
- Usage : Kitchen, Pantry, Refrigerator & More
- BPA Free : Yes
- Microwave Safe : No
- Dishwasher Safe : No
- Freezer Safe : Yes
- Package Includes : 6 Pcs Containers (1000 ML)
6 Pcs Airtight Lids



FOOD SAFE
100% food grade material, safe & healthy.



SPACE SAVER
Stackable design saves space and keeps your kitchen neat.



FRESH & ORGANIZED
Airtight seal keeps food fresh and your kitchen organized.



CRYSTAL CLEAR
Transparent design for easy visibility and quick identification.



BS-01

FRUIT DRAIN BASKET

SMART WASHING & DRAINING SOLUTION

Smart Design.
Fresh Everyday.

KEY FEATURES

- FOOD GRADE PLASTIC**
Made from premium food grade plastic, safe & non-toxic.
- BUILT-IN DRAIN HOLES**
Bottom & side drain holes allow water to flow out quickly.
- EASY POUR HANDLE**
Integrated handle for easy holding and pouring.
- MULTI-PURPOSE USE**
Ideal for washing fruits, vegetables, pasta and serving snacks.
- LIGHTWEIGHT & DURABLE**
Lightweight yet strong design for long-lasting everyday use.
- EASY TO CLEAN**
Smooth surface for quick rinsing and hassle-free cleaning.



SPECIFICATIONS

Product Code	: BS-01
Product Name	: Fruit Drain Basket
Material	: Food Grade Plastic (BPA Free)
Capacity	: Approx. 1500ml
Usage	: Washing & Draining
Color	: Transparent Smoke Grey
Handle	: Integrated Handle
Drain System	: Yes
Food Safe	: Yes
Dishwasher Safe	: Yes
Microwave Safe	: No
Suitable For	: Fruits, Vegetables, Pasta, Salads & More
Package Includes	: 1 Pc Fruit Drain Basket

IDEAL FOR EVERYDAY USE



- FOOD SAFE**
Safe for you and your family.
- EASY DRAINAGE**
Fast water drainage keeps food fresh.
- LIGHTWEIGHT**
Easy to handle and carry.
- EASY CLEANING**
Smooth surface for effortless cleaning.



SMART POURING.
HEALTHY COOKING.
MADE FOR EVERY KITCHEN!

OD-01
OIL DISPENSER
500ML

OIL DISPENSER 500ML

**Precise Pour.
Perfect Every Time.**

KEY FEATURES

- PRECISE POUR CONTROL**
Smooth pour spout for mess-free dispensing.
- FOOD GRADE MATERIAL**
Made with food grade materials for safe & healthy use.
- LEAK PROOF DESIGN**
Secure lid and silicone seal prevent leaks and spills.
- MEASUREMENT MARKINGS**
Clear scale for easy measurement & refilling.
- EASY TO CLEAN**
Wide mouth for effortless cleaning and refilling.

**PERFECT FOR
OILS, VINEGAR,
SAUCES &
MORE!**



SPECIFICATIONS

Product Code	: OD-01
Product Name	: Oil Dispenser
Capacity	: 500ML
Material	: Transparent Glass Body Food Grade Plastic (Lid & Handle)
Lid Type	: Flip Spout Lid
Usage	: Ideal for Oil, Vinegar, Sauces & Liquid Condiments
Weight	: 320GM (Approx.)

- LEAK PROOF**
Secure seal prevents leakage & mess
- BPA FREE**
Safe for you & your family
- DURABLE BUILD**
Strong, sturdy & built to last

USAGE



- PRECISE POUR SPOUT**
Controlled pouring without mess
- FOOD GRADE MATERIAL**
Safe, non-toxic & healthy for daily use
- MEASUREMENT SCALE**
Easy to measure & refill the right amount
- EASY TO CLEAN**
Detachable parts for easy cleaning
- PERFECT GIFT**
Stylish & practical

DOWNLOAD IMAGES

Cronus™ THANK YOU

THANK YOU FOR CHOOSING CRONUS KITCHENWARE

Enhancing Everyday Living with Quality, Innovation & Style.

GET IN TOUCH



FACTORY ADDRESS

Khodal Enterprise
National Highway 27, Near Parin Furniture,
Vavdi Industrial Area, Rajkot - 360004



MOBILE NUMBERS

+91 96622 32285
+91 73830 40305



OFFICE NUMBER

+91 70707 08124



EMAIL

CRONUSPRODUCT@GMAIL.COM



WEBSITE

cronus.co.in

OUR PRODUCT CATEGORIES

- ◆ Kitchen Storage Solutions
- ◆ Water Bottles & Drinkware
- ◆ Spice Racks & Organizers
- ◆ Lunch Boxes & Containers
- ◆ Dish Drying Racks
- ◆ Kitchen Tools & Accessories



SCAN TO EXPLORE

Our complete collection
and latest innovations.



SEE YOU IN OUR NEXT COLLECTION

2026 COLLECTION

Designed for Everyday. Crafted for Excellence.

Thank You for Choosing Cronus Kitchenware



PREMIUM QUALITY



DURABLE & RELIABLE

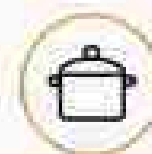

FOOD GRADE



THOUGHTFUL DESIGN